

Zawieszka FI-10-ZM-W

Nr ref C28116N00

Ref. arch 42242

- Podwieszenie wzdłużne na pręcie lub linie
- Mały gabaryt

PRZEZNACZENIE PRODUKTU

- do podwieszania opraw LED

MONTAŻ

- do pręta lub linki, za pomocą wkręta dociskowego
- do pręta, za pomocą wkręta dociskowego



RYSUNEK TECHNICZNY

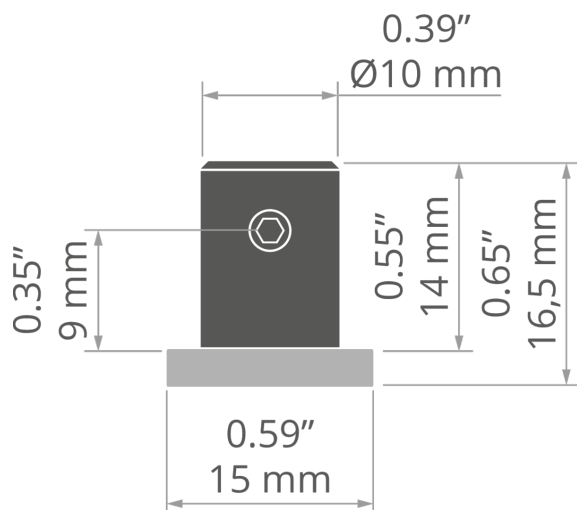

SPECYFIKACJA TECHNICZNA

Materiał	stal nierdzewna	Wysokość	16.5 mm
Kolor	■ srebrny	Średnica	10 mm
Szerokość	15 mm	Udźwig	30 kg

Zawieszka FI-10-ZM-W

Nr ref C28116N00

Ref. arch 42242

PROFILE POWIĄZANE > ARCHITEKTONICZNE



3035
A18039
Ref. arch 18039



3035-O
A08441
Ref. arch B8441

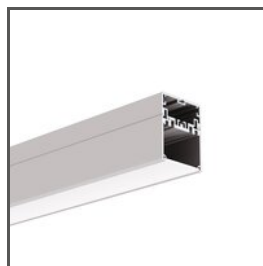

4050
A18050
Ref. arch 18050

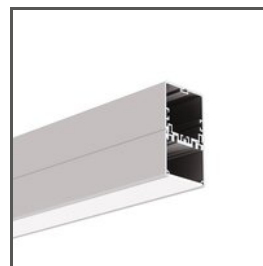

4050-W
A18051
Ref. arch 18051



GIZA
A05556
Ref. arch B5556

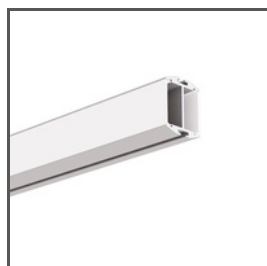

GIZA-DUO-LL
A02162
Ref. arch C2162



GIZA-LL
A00758
Ref. arch C0758



JAZ
A08547
Ref. arch B8547



LIPOD
A05554
Ref. arch B5554



OPK-4
A00370
Ref. arch C0370

PROFILE POWIĄZANE > DO OŚWIETLENIA GŁÓWNEGO

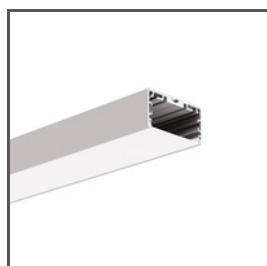

LIPOD-50
A02609
Ref. arch C2609

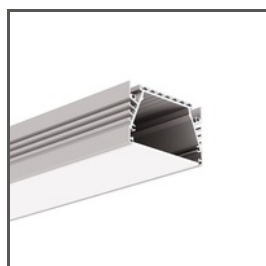

SEPOD
A06593
Ref. arch B6593

PROFILE POWIĄZANE > MINIMALISTYCZNE



PIKO-ZM
A01168
Ref. arch C1168

PROFILE POWIĄZANE > UNIWERSALNE

Zawieszka FI-10-ZM-W

Nr ref C28116N00

Ref. arch 42242



OLEK
A08505

Ref. arch B8505



PDS-ZM-PLUS
A02056

Ref. arch C2056

SYSTEMY POWIĄZANE > SYSTEMY DO OŚWIETLENIA OGÓLNEGO

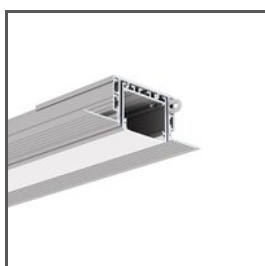

3035-KOZE

A08441+A18056

Ref. arch 18056+B8441



PK-4

A18044+A00370

Ref. arch 18044+C0370

POWIĄZANE AKCESORIA > INNE AKCESORIA > LINKI I PRĘTY

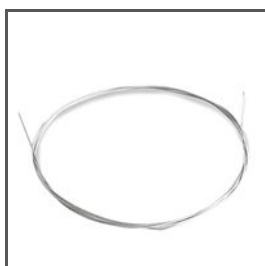

LINKA STALOWA

FI-1 1m

C24522N00

Ref. arch 1397

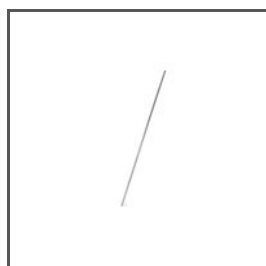

PRĘT

FI-3 1m

42501

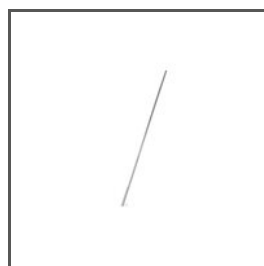

PRĘT

100 PUSZ 1 m

42518

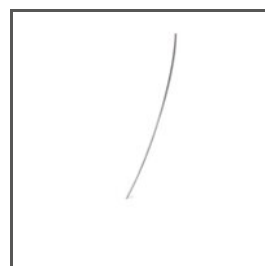

PRĘT

FI-3 53 cm

C24528N00

Ref. arch 1528

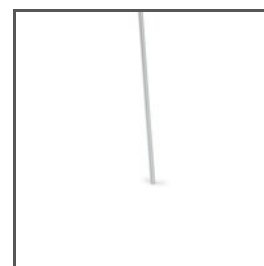

PRĘT

FI-3-ALU

C28196A01, C28196A07

Ref. arch 42526, 42527, 42528, 42529