

RF Single Color Remote Controller

09.289DM.04164



Important: Read All Instructions Prior to Installation

Function introduction

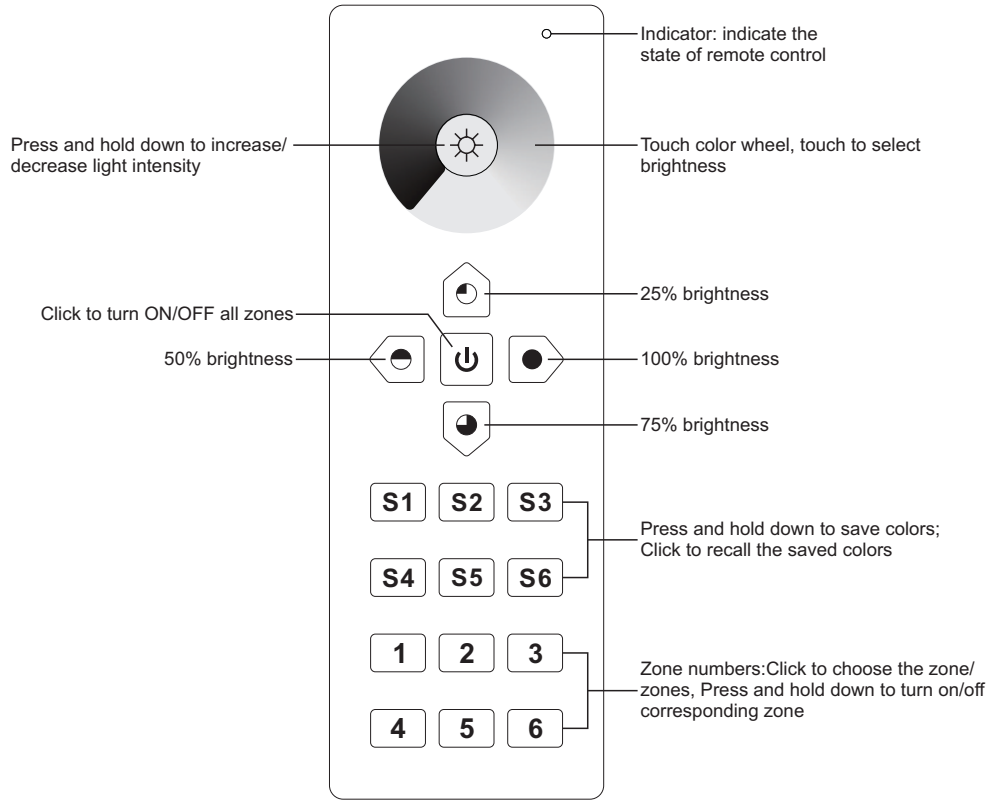

Front side

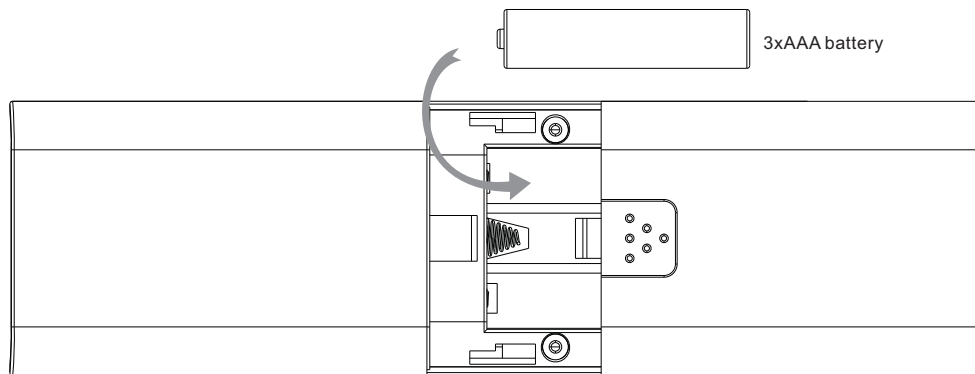

Bottom side

Product Data

Output	RF signal
Operation Frequency	869.5/916.5/434MHz
Power Supply	4.5V(3xAAA battery)
Operating temperature	0-40°C
Relative humidity	8% to 80%
Dimensions	140x48x17mm

- Control 6 zones of RF receivers separately.
- Single color controller
- High sensitive & high stable, fast & precise color control.
- Compatible with all universal series RF receivers
- 1 receiver can be paired by max 8 different remote controls.
- Waterproof grade: IP20

Safety & Warnings

- This device contains AAA batteries that shall be stored and disposed properly.
- DO NOT expose the device to moisture.

Pair with RF receiver(Method 1)

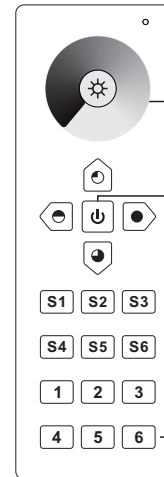

Step 1: Do wiring the RF receiver according to wiring diagram (please refer to the instruction of RF receiver that you would like to pair with).

Step 5: Touch the color wheel, LED lights connected with the RF receiver flicker once means the receiver is paired with zone 6 successfully.

Step 2: Click ON/OFF button to activate the remote

Step 3: Click the "Learning Key" button on RF receiver or re-power on the receiver three times continuously to set it into pairing status

Step 4: Choose and click a zone number (e.g. zone 6)



Pair with RF receiver(Method 2)

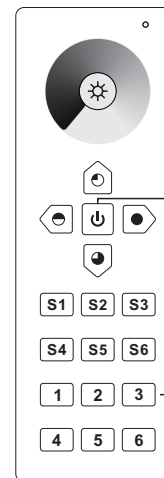

Step 1: Do wiring the RF receiver according to wiring diagram (please refer to the instruction of RF receiver that you would like to pair with).

Step 2: Click ON/OFF button to activate the remote

Step 3: Power off and power on the receiver

Step 4: Choose and click a zone number (e.g. zone 3) twice, then press and hold it continuously and quickly within 10 seconds, LED lights connected with the RF receiver flicker once means the receiver is paired with zone 3 successfully.



Save color/scene/mode

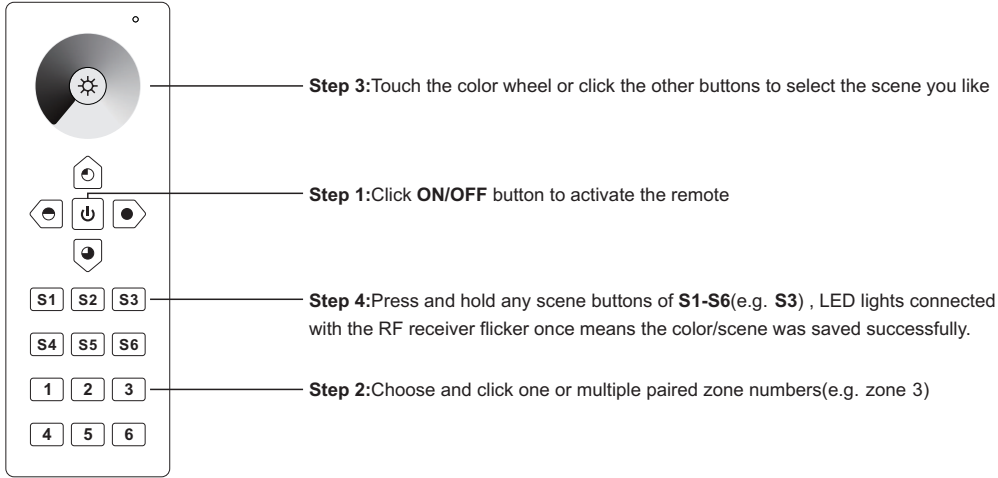

Recall the saved colors/scenes

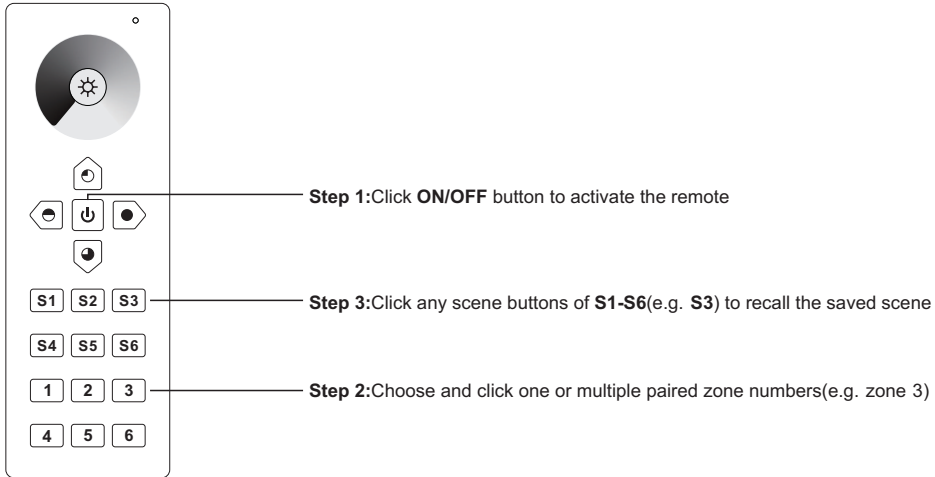

If you use multiple receivers, you have two choices:

Option 1: have all the receivers in the same zone, like zone 1

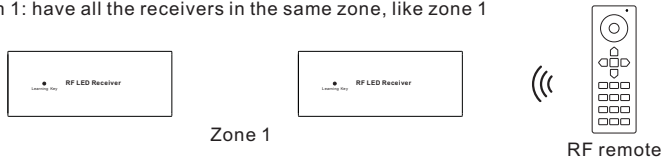

Option 2: have each receiver in a different zone, like zone 1, 2, 3 or 4

